

KLT-CMFL15101-IMX577 V1.0 12.3MP Sony IMX577 Fixed Focus Camera Module

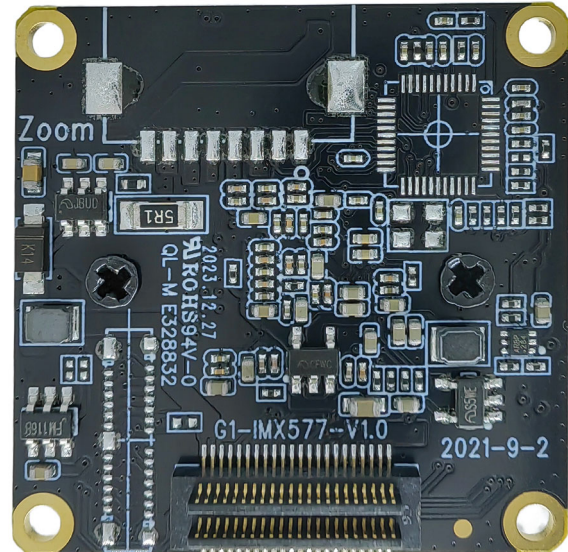

Front View



Back View

Overview

The KLT-CMFL15101-IMX577 V1.0 camera module uses the Sony IMX577 high-quality CMOS image sensor, which has a diagonal of 7.857mm (1/2.3 type) CMOS image sensor, a pixel size of 1.55um, a color square pixel display, an effective pixel of 12 megapixels, and a high-definition image. When used with the master board, it can support 12MP high-definition photos, and can support up to 4K@60FPS (differential), 4K@30FPS video shooting.

Used with the master board, the coaxial cable is used to connect the main board or by directly plug in. The board frame size is 32x32mm, and the size from the top of the module lens to the PCB board surface is 30.5mm.

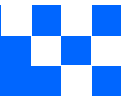

KLT-CMFL15101-IMX577 V1.0
12.3MP Sony IMX577 Fixed Focus Camera Module

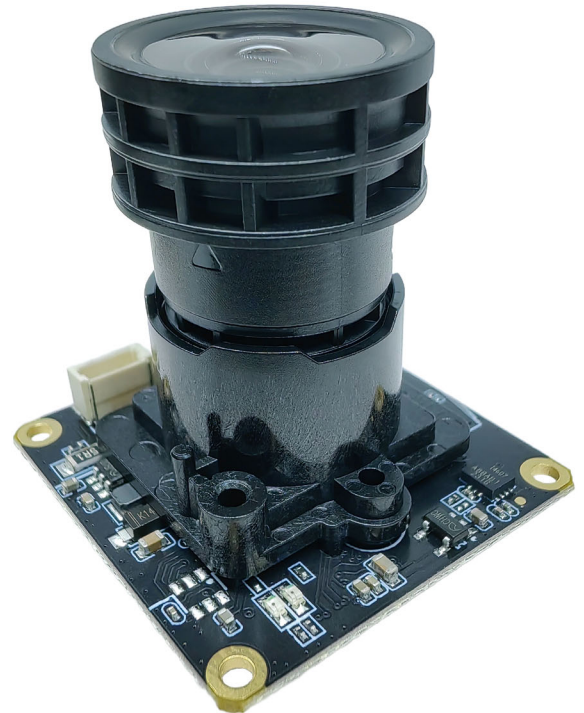



KLT-CMFL15101-IMX577 V1.0 12.3MP Sony IMX577 Fixed Focus Camera Module

Specifications

Model No.	KLT-CMFL15101-IMX577 V1.0
Image Sensor	IMX577
Image Sensor Type	CMOS
Effective Pixels	12.3 Megapixels
Sensor Size	1/2.3"
Pixel Size	1.55 um x 1.55 um
Video Frame Rate	4K@24/25/30/FPS, 4K@48/50/60FPS (Differential) 2.7K@24/25/30/48/50/60FPS 1080P@24/25/30/48/50/60/120FPS 720P@24/25/30/48/50/60/120/240FPS
Video Slow Motion	OFF, 4K2X, 1080P4X, 720P8X
Photo Resolution (with Master Board)	20MP (5200x3900) (Differential) 13MP (4160x3120) (Differential) 12MP (4000x3000) 10MP (3648x2736) 8MP (3264x2448) 5MP (2592x1944) 3MP (2048x1536) 2MP (1920x1080)
Operating Temperature	-10°C to +60°C
Storage Temperature	-20°C to +80°C
Humidity	20% to 80%
PCB Dimensions	32 x 32 mm
Module Size	32 x 32 x 24 mm
PCB Screw Hole Spacing	28 x 28 mm
PCB Screw Hole Diameter	2 mm
Lens Mount Screw Diameter	1.6 mm

KLT-CMFL15101-IMX577 V1.0

12.3MP Sony IMX577 Fixed Focus Camera Module

Lens Specifications

Lens Model No.	HX15101
EFL (Focal Length)	5.1 mm
BFL	3.91 mm
TTL (Total Length)	30 mm
F. No.	1.00
Lens Barrel Thread	M16 x P0.5
Lens Construction	1G6P
Diagonal View Angle (DFOV)	96.3° (DFOV) ($y' = 7.90$ mm)
Horizontal View Angle (HFOV)	74.5° (HFOV) ($y' = 6.31$ mm)
Vertical View Angle (VFOV)	54.8° (VFOV) ($y' = 4.75$ mm)
Chief-Ray Angle	10.3°
Distortion	-11.10%
Relative Illumination	>47.6%
Lens Operating Temperature	-20°C to +60°C
Lens Storage Temperature	-30°C to +80°C

Lens Drawing

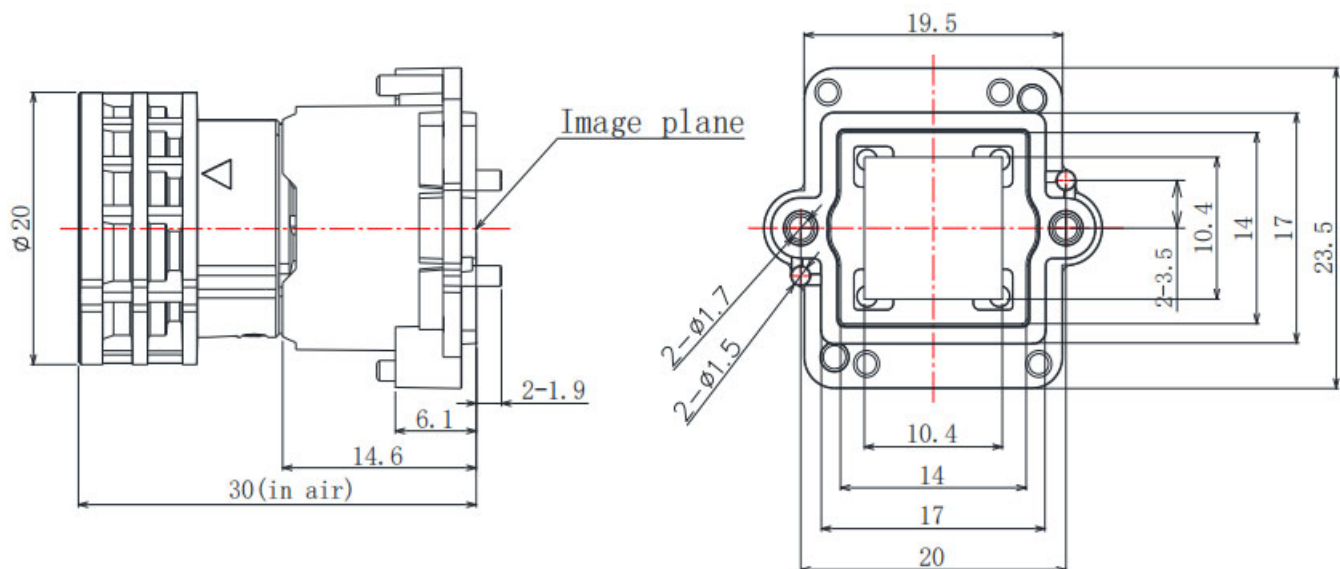

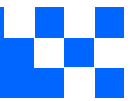
**KLT-CMFL15101-IMX577 V1.0****12.3MP Sony IMX577 Fixed Focus Camera Module**

**G1-IMX577 HX15101
V1.0 镜头模组**

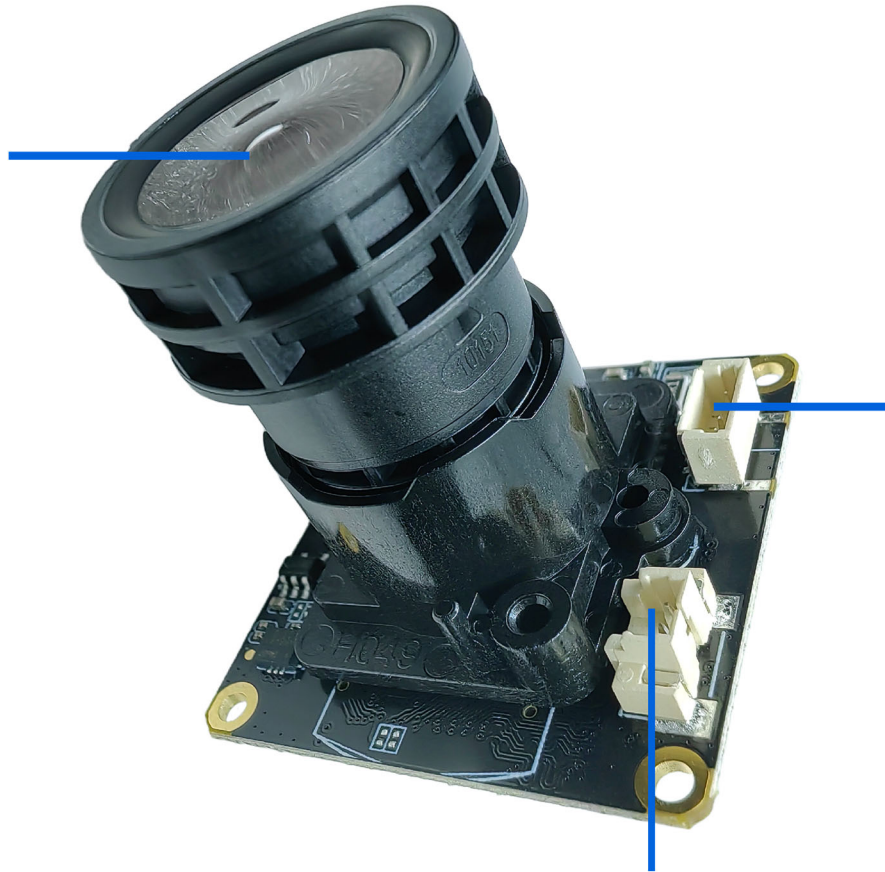

**两组 LED 补光灯接口
LEDS * 2 INTERFACE**

滤光片切换器接口

IR-CUT INTERFACE

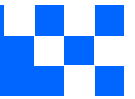

KLT-CMFL15101-IMX577 V1.0
12.3MP Sony IMX577 Fixed Focus Camera Module

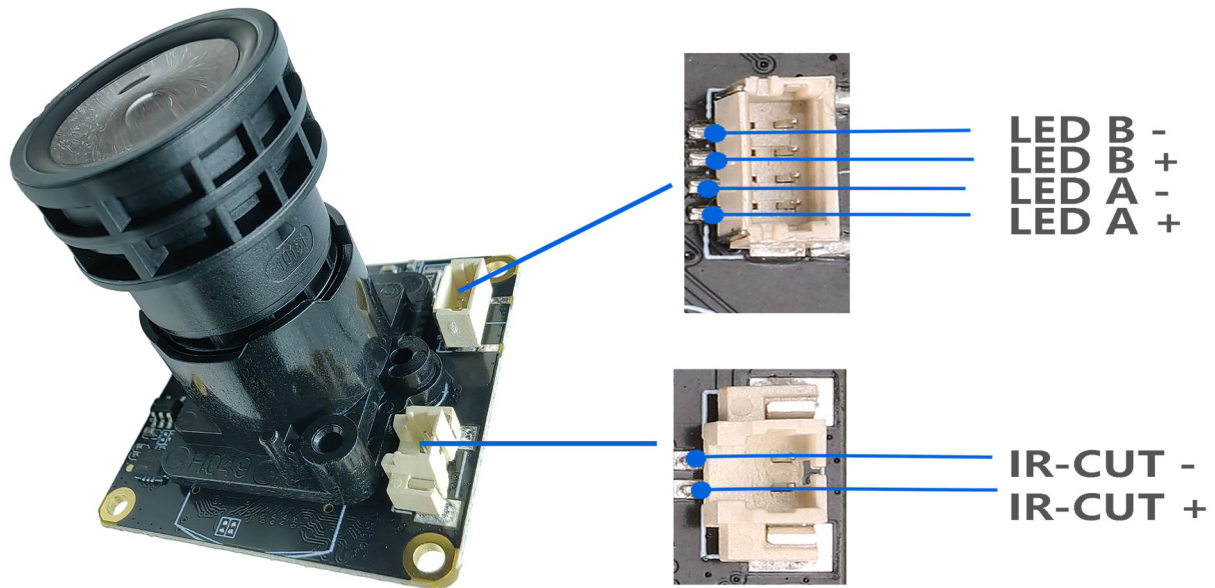

Special Note:

The two sets of fill light interfaces support the expansion of infrared light and white light boards to provide fill light for the device. If you need the fill light function, you need to add the KLT-LEDP V2.0 White and Infrared Light LED Plate.

When used with the IR cut filter lens, the infrared light can be switched automatically or manually, making videos and photos clearer at night.

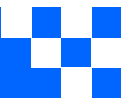

KLT-CMFL15101-IMX577 V1.0
12.3MP Sony IMX577 Fixed Focus Camera Module

**通过板对板连接器连接G1主板
支持Sensor、IR-CUT、LED等**

Connect Sensor、IR-CUT、LED etc.

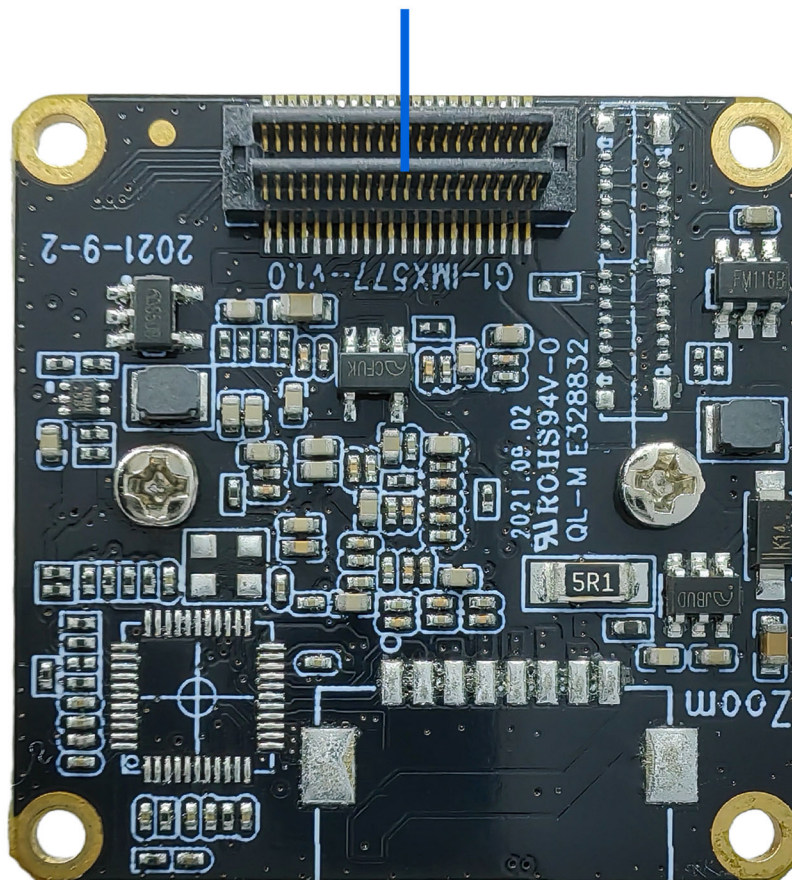

[Product Information]

Ver.1.0

IMX577-AACK

Diagonal 7.857 mm (Type 1/2.3) 12.3 Mega-Pixel CMOS Image Sensor with Square Pixel for Color Cameras

Description

The IMX577-AACK is a diagonal 7.857 mm (Type 1/2.3) 12.3 Mega-pixel CMOS active pixel type stacked image sensor with a square pixel array. It adopts Sony's Stacked CMOS Image Sensor technology to achieve high speed image capturing by column parallel A/D converter circuits and high sensitivity and low noise image (comparing with conventional CMOS image sensor) through the backside illuminated imaging pixel structure. R, G, and B pigment primary color mosaic filter is employed. It equips an electronic shutter with variable integration time. It operates with three power supply voltages: analog 2.8 V, digital 1.05 V and 1.8 V for input/output interface and achieves low power consumption.

In addition, this product is designed for use in consumer use camcorder. When using this for another application, Sony Semiconductor Solutions Corporation does not guarantee the quality and reliability of product. Therefore, don't use this for applications other than consumer use camcorder.

In addition, individual specification change cannot be supported because this is a standard product.

Consult your Sony Semiconductor Solutions Corporation sales representative if you have any questions.

Features

- ◆ Back-illuminated and stacked CMOS image sensor
- ◆ Digital Overlap High Dynamic Range (DOL-HDR) mode with raw data output.
- ◆ High signal to noise ratio (SNR).
- ◆ Full resolution @60 frame/s (Normal), 4K2K @60 frame/s (Normal), 1080p @240 frame/s
Full resolution @40 frame/s (12 bit Normal), Full resolution @30 frame/s (DOL-HDR, 2 frame)
- ◆ Output video format of RAW12/10/8, COMP8.
- ◆ Power Save Mode with MIPI ULPS operation
- ◆ Pixel binning readout and V sub-sampling function.
- ◆ Independent flipping and mirroring.
- ◆ Input clock frequency 6 to 27 MHz
- ◆ CSI-2 serial data output (MIPI 2lane/4lane, Max. 2.1 Gbps/lane, D-PHY spec. ver. 1.2 compliant)
- ◆ 2-wire serial communication.
- ◆ Two PLLs for independent clock generation for pixel control and data output interface.
- ◆ Defect Pixel Correction (DPC)
- ◆ Ambient Light Sensor (ALS)
- ◆ Fast mode transition. (on the fly)
- ◆ Dual sensor synchronization operation (Multi camera compatible)
- ◆ 7 k bit of OTP ROM for users.
- ◆ Built-in temperature sensor
- ◆ 10-bit/12-bit A/D conversion on chip
- ◆ Horizontal Low Power Analog Cropping
- ◆ Window Scanning mode
- ◆ 92-pin high-precision ceramic package

Sony reserves the right to change products and specifications without prior notice.

Sony logo is a registered trademark of Sony Corporation.

Device Structure

- ◆ CMOS image sensor
- ◆ Image size Diagonal 7.857 mm (Type 1/2.3)
- ◆ Total number of pixels 4072 (H) × 3176 (V) approx. 12.93 M pixels
- ◆ Number of effective pixels 4072 (H) × 3064 (V) approx. 12.47 M pixels
- ◆ Number of active pixels 4056 (H) × 3040 (V) approx. 12.33 M pixels
- ◆ Chip size 7.564 mm (H) × 5.476 mm (V)
- ◆ Unit cell size 1.55 μm (H) × 1.55 μm (V)
- ◆ Package 92 pin LGA

Image Sensor Characteristics

(Tj = 60 °C)

Item		Value	Remarks
Sensitivity (F2.8)	Min.	250 LSB	1/120 s integration
Saturation signal	Min.	1023 LSB	

Basic Drive Mode

Drive mode	Number of active pixels	Maximum frame rate [frame/s]	Output interface	ADC [bit]
Full (4:3) (Normal)	4056 (H) × 3040 (V) approx. 12.33 M pixels	60	CSI-2	10
		43	CSI-2	12
Full (4:3) (DOL-HDR)	4056 (H) × 3040 (V) approx. 12.33 M pixels	DOL 2 frame : 30 DOL 3 frame : 15	CSI-2	10
Full (16:9) 4K2K (Normal)	4056 (H) × 2288 (V) approx. 9.28 M pixels	79	CSI-2	10
Full (16:9) 4K2K (DOL-HDR)	4056 (H) × 2288 (V) approx. 9.28 M pixels	DOL 2 frame : 39 DOL 3 frame : 19	CSI-2	10
Full (4:3) Binning (Normal)	2028 (H) × 1520 (V) approx. 3.08 M pixels	178	CSI-2	10
Full (16:9) Binning 1080P (Normal)	2028 (H) × 1112 (V) approx. 2.26 M pixels	241	CSI-2	10
Full (16:9) Binning 720P (Normal)	1352 (H) × 740 (V) approx. 1.00 M pixels	241	CSI-2	10
Full (16:9) Scaling 1080P (Normal)	2028 (H) × 1144 (V) approx. 2.32 M pixels	79	CSI-2	10
Full (16:9) Scaling 720P (Normal)	1352 (H) × 762 (V) approx. 1.03 M pixels	79	CSI-2	10



Cameras Applications



Automotive Driver Pilot



Live Streaming



Video Conference



Eye Tracker Biometric Detection

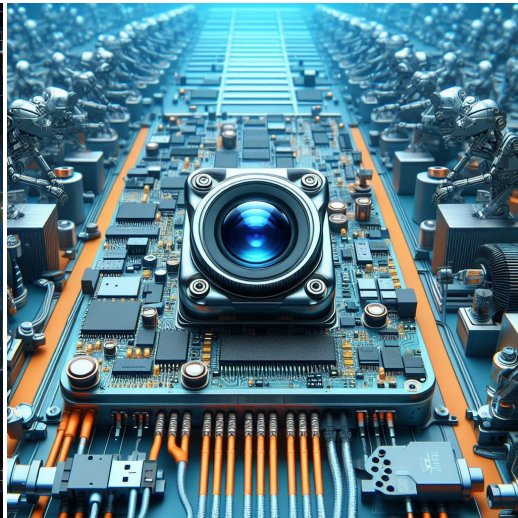

Machine Vision



Agricultural Monitor

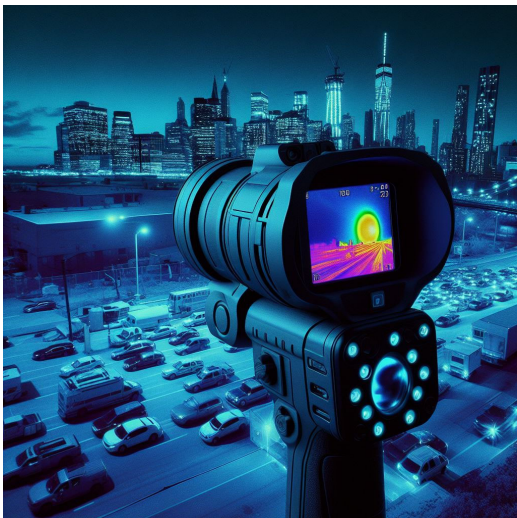

Night Vision Security



Drone and Sports Eagle Eyes



Interactive Pet Camera



your BEST camera module partner

Cameras Applications

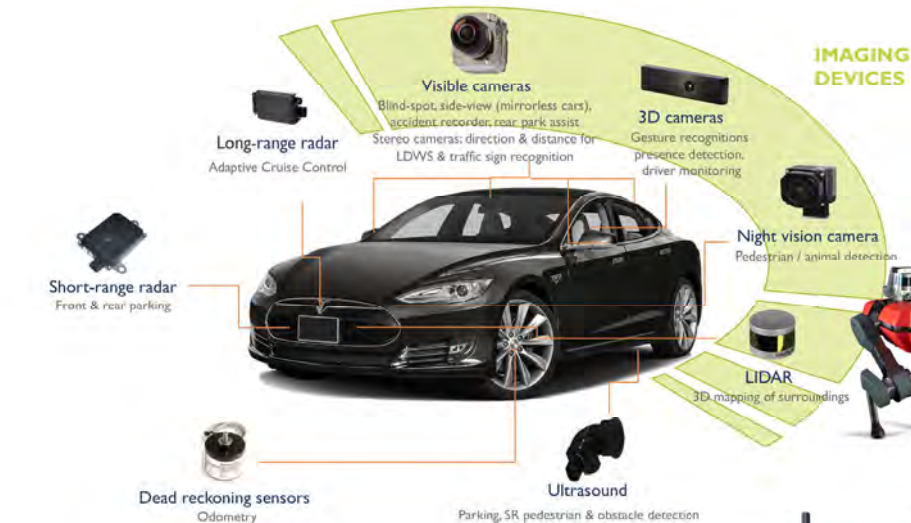

IMAGING DEVICES





Camera Module Pinout Definition Reference Chart

OmniVision	Sony	Samsung	On-Semi	Aptina	Himax	GalaxyCore	PixArt	SmartSens	Sensors	
Pin Signal										
Description										
DGND GND										ground for digital circuit
AGND										ground for analog circuit
PCLK DCK										DVP PCLK output
XCLR PWDN XSHUTDOWN STANDBY										power down active high with internal pull-down resistor
MCLK XVCLK XCLK INCK										system input clock
RESET RST										reset active low with internal pull-up resistor
NC NULL										no connect
SDA SIO_D SIOD										SCCB data
SCL SIO_C SIOC										SCCB input clock
VSYNC XVS FSYNC										DVP VSYNC output
HREF XHS										DVP HREF output
DOVDD										power for I/O circuit
AFVDD										power for VCM circuit
AVDD										power for analog circuit
DVDD										power for digital circuit
STROBE FSTROBE										strobe output
FSIN										synchronize the VSYNC signal from the other sensor
SID										SCCB last bit ID input
ILPWM										mechanical shutter output indicator
FREQ										frame exposure / mechanical shutter
GPIO										general purpose inputs
SLASEL										I2C slave address select
AFEN										CEN chip enable active high on VCM driver IC
MIPI Interface										
MDN0 DN0 MD0N DATA_N DMO1N										MIPI 1st data lane negative output
MDP0 DP0 MD0P DATA_P DMO1P										MIPI 1st data lane positive output
MDN1 DN1 MD1N DATA2_N DMO2N										MIPI 2nd data lane negative output
MDP1 DP1 MD1P DATA2_P DMO2P										MIPI 2nd data lane positive output
MDN2 DN2 MD2N DATA3_N DMO3N										MIPI 3rd data lane negative output
MDP2 DP2 MD2P DATA3_P DMO3P										MIPI 3rd data lane positive output
MDN3 DN3 MD3N DATA4_N DMO4N										MIPI 4th data lane negative output
MDP3 DP3 MD3P DATA4_P DMO4P										MIPI 4th data lane positive output
MCN CLKN CLK_N DCKN										MIPI clock negative output
MCP CLKP MCP CLK_P DCKN										MIPI clock positive output
DVP Parallel Interface										
D0 DO0 Y0										DVP data output port 0
D1 DO1 Y1										DVP data output port 1
D2 DO2 Y2										DVP data output port 2
D3 DO3 Y3										DVP data output port 3
D4 DO4 Y4										DVP data output port 4
D5 DO5 Y5										DVP data output port 5
D6 DO6 Y6										DVP data output port 6
D7 DO7 Y7										DVP data output port 7
D8 DO8 Y8										DVP data output port 8
D9 DO9 Y9										DVP data output port 9
D10 DO10 Y10										DVP data output port 10
D11 DO11 Y11										DVP data output port 11



Camera Reliability Test

Reliability Inspection Item		Testing Method	Acceptance Criteria	
Category	Item			
Environmental	Storage Temperature	High 60°C 96 Hours	Temperature Chamber	No Abnormal Situation
		Low -20°C 96 Hours	Temperature Chamber	No Abnormal Situation
	Operation Temperature	High 60°C 24 Hours	Temperature Chamber	No Abnormal Situation
		Low -20°C 24 Hours	Temperature Chamber	No Abnormal Situation
	Humidity	60°C 80% 24 Hours	Temperature Chamber	No Abnormal Situation
	Thermal Shock	High 60°C 0.5 Hours Low -20°C 0.5 Hours Cycling in 24 Hours	Temperature Chamber	No Abnormal Situation
Physical	Drop Test (Free Falling)	Without Package 60cm	10 Times on Wood Floor	Electrically Functional
		With Package 60cm	10 Times on Wood Floor	Electrically Functional
	Vibration Test	50Hz X-Axis 2mm 30min	Vibration Table	Electrically Functional
		50Hz Y-Axis 2mm 30min	Vibration Table	Electrically Functional
		50Hz Z-Axis 2mm 30min	Vibration Table	Electrically Functional
	Cable Tensile Strength Test	Loading Weight 4 kg 60 Seconds Cycling in 24 Hours	Tensile Testing Machine	Electrically Functional
Electrical	ESD Test	Contact Discharge 2 KV	ESD Testing Machine	Electrically Functional
		Air Discharge 4 KV	ESD Testing Machine	Electrically Functional
	Aging Test	On/Off 30 Seconds Cycling in 24 Hours	Power Switch	Electrically Functional
	USB Connector	On/Off 250 Times	Plug and Unplug	Electrically Functional





Inspection Item		Inspection Method	Standard of Inspection		
Category	Item				
Appearance	FPC/ PCB	Color	The Naked Eye	Major Difference is Not Allowed.	
		Be Torn/Chopped	The Naked Eye	Copper Crack Exposure is Not Allowed.	
		Marking	The Naked Eye	Clear, Recognizable (Within 30cm Distance)	
	Holder	Scratches	The Naked Eye	The Inside Crack Exposure is Not Allowed	
		Gap	The Naked Eye	Meet the Height Standard	
		Screw	The Naked Eye	Make Sure Screws Are Presented (If Any)	
		Damage	The Naked Eye	The Inside Crack Exposure is Not Allowed	
	Lens	Scratch	The Naked Eye	No Effect On Resolution Standard	
		Contamination	The Naked Eye	No Effect On Resolution Standard	
		Oil Film	The Naked Eye	No Effect On Resolution Standard	
		Cover Tape	The Naked Eye	No Issue On Appearance.	
	Function	Image	No Communication	Test Board	Not Allowed
			Bright Pixel	Black Board	Not Allowed In the Image Center
Dark Pixel			White board	Not Allowed In the Image Center	
Blurry			The Naked Eye	Not Allowed	
No Image			The Naked Eye	Not Allowed	
Vertical Line			The Naked Eye	Not Allowed	
Horizontal Line			The Naked Eye	Not Allowed	
Light Leakage			The Naked Eye	Not Allowed	
Blinking Image			The Naked Eye	Not Allowed	
Bruise			Inspection Jig	Not Allowed	
Resolution			Chart	Follows Outgoing Inspection Chart Standard	
Color			The Naked Eye	No Issue	
Noise			The Naked Eye	Not Allowed	
Corner Dark			The Naked Eye	Less Than 100px By 100px	
Color Resolution			The Naked Eye	No Issue	
Dimension	Height	The Naked Eye	Follows Approval Data Sheet		
	Width	The Naked Eye	Follows Approval Data Sheet		
	Length	The Naked Eye	Follows Approval Data Sheet		
	Overall	The Naked Eye	Follows Approval Data Sheet		



KLT Package Solutions

KLT Camera Module



Complete with Lens Protection Film



Tray with Grid and Space



Place Cameras on the Tray





Camera Modules Package Solution

Full Tray of Cameras



Cover Tray with Lid



Put Tray into Anti-Static Bag



Vacuum the Anti-Static Bag

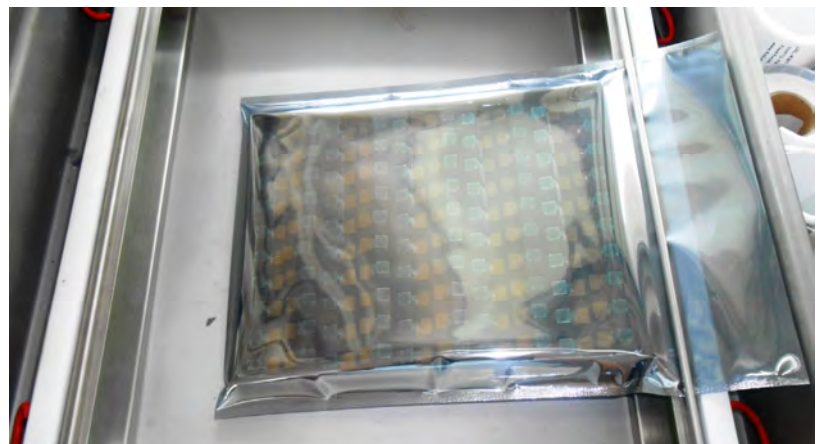



Camera Modules Package Solution

Sealed Vacuum Bag with Labels

1. Model and Description 2. Quantity 3. Shipping Date 4. Caution





Large Order Package Solution

Place Foam Sheets Between Trays



Foam Sheets are Slightly Larger than Trays



Place Foam Sheets and Trays into Box



Foam Sheets are Tightly Fitting Box





Small Order Package Solution

Place Foam Sheets and Trays into Small Box



Foam Sheets are Nicely Fitting the Small Box



Package in Small Box for Shipment



Place Small Boxes into Larger Box





your BEST camera module partner

Carbon Box Package Solution

Seal the Carbon Box

Final Package Labelled Box



Carbon Box Ready for Shipment

1. Delivery Address and Phone No. 2. Box No. and Ship Date 3. Fragile Caution





Sample Order Package Solution

Place Sample into Small Anti-Static Bag



Place Connectors into Small Ant-Static Bag



Sample Labels on the Small Bag

1. Camera Module or Connector Model
2. Shipping Date and Quantity
3. Caution





your BEST camera module partner

Connectors Large Order Package Solution

Connectors in a Wheel



Label Connectors in the Wheel



The Wheel is Perfectly Fitting the Box



Connectors Box Ready for Shipment





your BEST camera module partner

Company Kai Lap Technologies (KLT)

Kai Lap Technologies Group Limited. (KLT) was established in 2009, a next-generation technology driven manufacturer specialized in research, design, and produce of audio and video products. KLT is occupying 20,000 square feet automated plants with 100 employees of annual throughput 30,000,000 units cameras.

KLT provides OEM, ODM design, contract manufacturing, and builds the camera products. You may provide the requirements to us, even with a hand draft, our sales and engineering work together to meet your needs. We consider ourselves your last-term partner in developing practical and innovative solutions.

Our team covers everything from initial concept development to mass produced product. KLT specializes in customized camera design, raw material, electronic engineering, firmware/software development, product testing, and packing design. Our experienced strategic supply systems offer a robust and dependable manufacturing capacity for orders of various sizes.

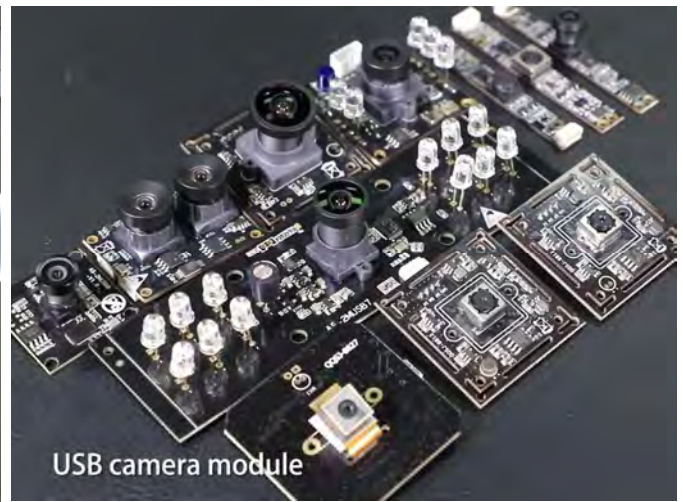

Limited Warranty

KLT provides the following limited warranty if you purchased the Product(s) directly from KLT company or from KLT's website, www.KaiLapTech.com. Product(s) purchased from other sellers or sources are not covered by this Limited Warranty. KLT guarantees that the Product(s) will be free from defects in materials and workmanship under normal use for a period of one (1) year from the date you receive the product ("Warranty Period").

For all Product(s) that contain or develop material defects in materials or workmanship during the Warranty Period, KLT will, at its sole option, either: (i) repair the Product(s); (ii) replace the Product(s) with a new or refurbished Product(s) (replacement Product(s) being of identical model or functional equivalent); or (iii) provide you a refund of the price you paid for the Product(s).

This Limited Warranty of KLT is solely limited to repair and/or replacement on the terms set forth above. KLT is not reliable or responsible for any subsequent events.





CMOS CAMERA MODULES



your BEST camera module partner

KLT Strength

Powerful Factory



Professional Service



Promised Delivery



www.KaiLapTech.com sales@KaiLapTech.com Tel: (852) 6908 1256 Fax: (852) 3017 6778

All rights reserved @ Kai Lap Technologies Group Ltd. Specifications subject to change without notice.